

ENGLISH



LASERFILTER

# BORN TO RUN.

➤ POWERFUL FILTRATION

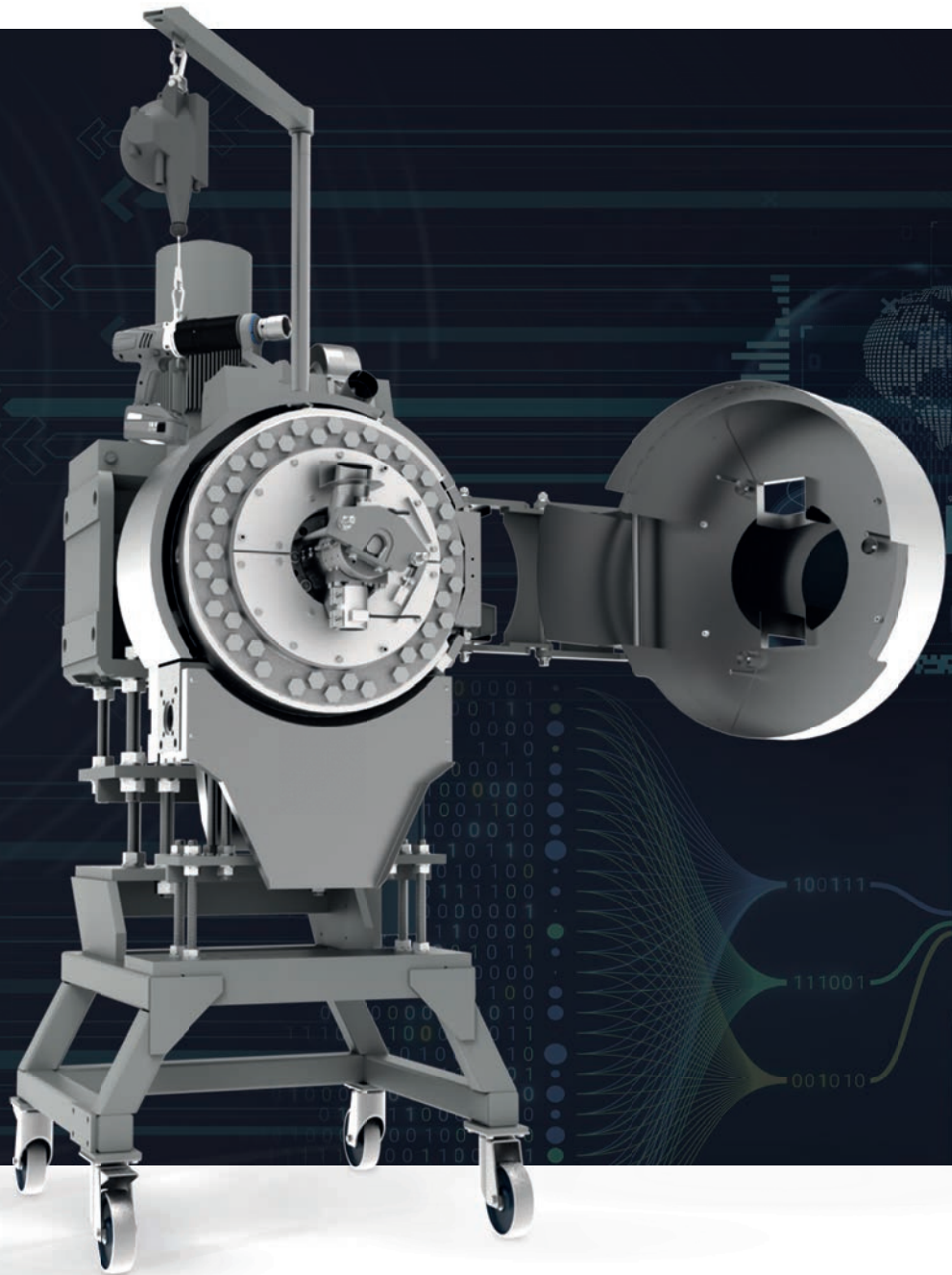

 **POWERFIL**<sup>®</sup>  
EREMA FILTER SYSTEMS



## PLUG IN PERFORMANCE.

---

**You have the extruder, we have the right filter. Whether you are a producer or a recycler. And regardless of whether you process heavily contaminated post-consumer plastic, post-industrial films with paper labels or relatively clean PET material: with POWERFIL you can count on high-performance filters that can best master these and many other challenging filtration tasks.** Our commitment is “Plug in Performance” . Because we offer you filters which demonstrate and underpin their capabilities on a daily basis: high capacities even with high degrees of contamination, plus fine filtration and perfect melt quality, high process consistency, a robust design for a long service life and fast amortisation. You receive systems which have been tried and tested thousands of times and have also put their reliability to the test in the toughest of recycling conditions. This is what we mean by “Performance” . And with “Plug in” we express that it is extremely easy for you to connect this performance package to your existing extrusion plant: thanks to fast filter availability and only a few necessary manual steps, you are ready to produce in no time at all. Our two filter models – the EREMA SW RTF® and the EREMA LASERFILTER – are available in a wide range of sizes, versions and capacity options. This is how we find the right solution for your specific requirements.

## PLUG IN PERFORMANCE.



### PLUG IN EFFICIENCY.

Perfect design, high-precision manufacturing and a robust build – POWERFIL filters have particularly strong throughput and ensure outstanding melt quality at the same time. They are available quickly and can be connected to your existing extrusion system manually in no time at all.



### PLUG IN PROFITABILITY.

Filters that get more out for you: strong throughput, minimum labour requirements, long screen change intervals, fast amortisation and a long service life. For more productivity and maximum profitability.



### PLUG IN RELIABILITY.

Contaminants are removed reliably and precisely. And: what is clean, also stays clean. Because the systems are perfectly sealed. For high melt quality, constant processes and top level filtration reliability.



### PLUG IN EXPERIENCE.

POWERFIL is part of EREMA, the plastics recycling pioneer and global market leader. The filters have been tried and tested hundreds and thousands of times, put their reliability to the test in the toughest of recycling conditions and are constantly optimised.

## INDEX.

06	The right decision: EREMA SW RTF® or Laserfilter
08	DischargePro – the innovative discharge control
10	The new Laserfilters
12	Expert for demanding contaminants
14	Material-Allrounder
16	The efficiency of the Laserfilter
18	How the Laserfilter works
22	The screen
24	The scraper star with discharge system
26	The Laserfilter series at a glance
28	Filtration systems overview
30	Lock & Change
31	Best practice example

# STRONG SYMBIOSIS. YOUR EXTRUDER. OUR FILTER.

**Robust backflusher or continuous high-performance filter?** Your application, the degree of contamination of your material and your requirements in terms of throughput are decisive in the choice of the right filtration system. The POWERFIL range offers you two high-performance filter series from EREMA for this: SW RTF® and Laserfilter. Regardless of which system you choose: with POWERFIL you are making a safe decision.

## ♻️ RAISED IN RECYCLING.

**Robust, strong and optimised without any compromises to ensure the cleanest melt quality even with high degrees of contamination.** Whether you decide in favour of the EREMA SW RTF® or the EREMA LASERFILTER: the reliability of the POWERFIL brand filters has been proven in the toughest recycling conditions. And this is because POWERFIL is part of EREMA, the plastics recycling pioneer and global market leader. These decades of experience and technical finesse are in the genes of every single filter. Experience and performance that you can trust.



### YOUR EXISTING EXTRUDER

Extruder from an alternative supplier  
(non-EREMA extruder)

## EREMA SW RTF® Robust backflusher

- Ideal for medium contaminants
- Up to 0.2 % contaminant content (dust, paper, wood, aluminium, etc.)
- Materials/polymers: all polyolefins, PA, PET, etc.
- Filtration fineness: up to 30 µm
- Automatic partial area backflushing with high cleaning efficiency
- Processing of high levels of flushing and surge contaminants through large active total screen areas
- Long screen change intervals
- Long piston service life through automatic pressure compensation (two opposite screens for each carrier piston)
- Minimum labour required



↑  
FINE SCREENS.  
CLEAN MELT.

## EREMA LASERFILTER Pure performance

- Ideal for severe contamination
- Up to 5 % contaminant content (dust, paper, wood, aluminium, copper, rubber/silicone, etc.)
- Materials/polymers: all polyolefins, PA, ABS, PET, etc.
- Filtration fineness: up to 70 µm
- High-performance filter for continuous contaminant discharge
- High throughputs even with high degrees of contamination
- Continuous screen cleaning
- Constant pressure operation for high process stability
- Minimum melt loss through thickening up to 50 %
- Extremely long screen service life
- Minimum labour required



↑  
EFFECTIVE AGAINST HEAVY  
CONTAMINATION. CONTINUOUSLY!

# DischargePro. THE INNOVATIVE DISCHARGE CONTROL.

## CLEAN MELT. THE SMART WAY.

**DischargePro.** The new, particularly sophisticated control system of the EREMA Laserfilter gets more out of it for you. **Continuously!** Greater efficiency, more stable processes and increased operating convenience with reduced time and labour costs. Another plus: depending on the application and contamination, the new control system reduces melt loss during filtration by up to 50 %\*) – for more recycled pellets and efficiency.

## CONSISTENT THICKENING, CONSTANT PROCESS.

The new discharge control system reacts to fluctuations in contamination in the input material by constantly adjusting the rotation speed of the filter scraper disc and discharge screw as required. This smart innovation ensures consistent thickening during melt filtration - an important parameter for a constant and economical process.

\*) compared to the previous EREMA Laserfilter control system, depending on application, material, degree and type of contamination, etc.



## DischargePro Control. Smart advantages:

- **EASIER OPERATION, MORE AUTOMATION:** significantly less adjustment and testing work for operators
- **COST SAVING:** less time and labour required, longer screen life
- **HIGHER PROCESS CONSISTENCY AND FILTRATION QUALITY:** control system recognises contamination fluctuations in the input material and compensates for these by adjusting the rotation speed as required – for constant thickening during melt filtration
- **OPTIMUM THICKENING RATIO** for a high proportion of filtered contaminants (paper, wood, aluminium, etc.) and low proportion of melt in the filter discharge
- **UP TO 50 % LOWER MELT LOSS\*)** during filtration means more recycled pellets at the end of the process and therefore an additional economic advantage
- **MORE COST EFFECTIVENESS, MORE PRODUCTIVITY**

Trend curve Laserfilter control

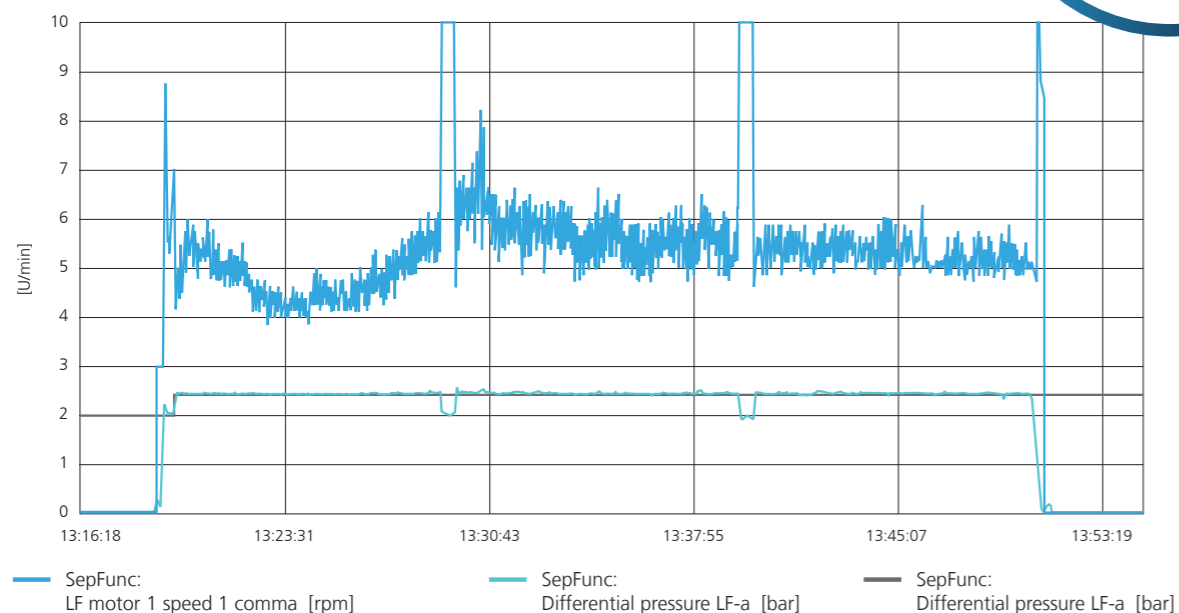

# 50 % MORE SCREEN AREA. THE NEW 406 LASERFILTER.

## QUALITY AT ITS BEST.



Already proven, now even larger. The area of the screen on the new EREMA 2/406 laserfilter is 50 % larger than on the 2/356 laserfilter. A strong advantage when melt quality and filtration fineness are at the top of the agenda. The increased screen area means that significantly more melt can be filtered per unit of time for applications where throughput is the key factor. Now you get even better results in quality-sensitive plastics applications.

## BORN TO RUN. LASERFILTER 2/356 & LASERFILTER 2/406.

- More ergonomic
- More user-friendly
- Safer
- Even easier removal of the discharge screw
- Low labour costs thanks to a high degree of automation

The new Laserfilter 2/356 is the well thought-out optimisation of its predecessor model, the Laserfilter 2/354. In terms of ease of operation and safety, the 2/356 takes its cue from the larger 2/406 series – and makes no compromises when it comes to robustness, reliability and productivity. True to the Laserfilter credo „Born to run“.

## EREMA Laserfilter 406. More area, more advantages.

- 
**EVEN HIGHER THROUGHPUTS**  
 ALSO WITH HIGH LEVELS  
 OF CONTAMINATION
- 
**FINER FILTRATION**  
 WITH THE SAME THROUGHPUT
- 
**BETTER MELT QUALITY**  
 DUE TO LOWER PRESSURE  
 AND TEMPERATURE AT  
 THE SAME THROUGHPUT

## MORE THROUGHPUT

For applications where throughput is the focus, the expanded screen area means that significantly more plastic melt can be filtered per unit of time.

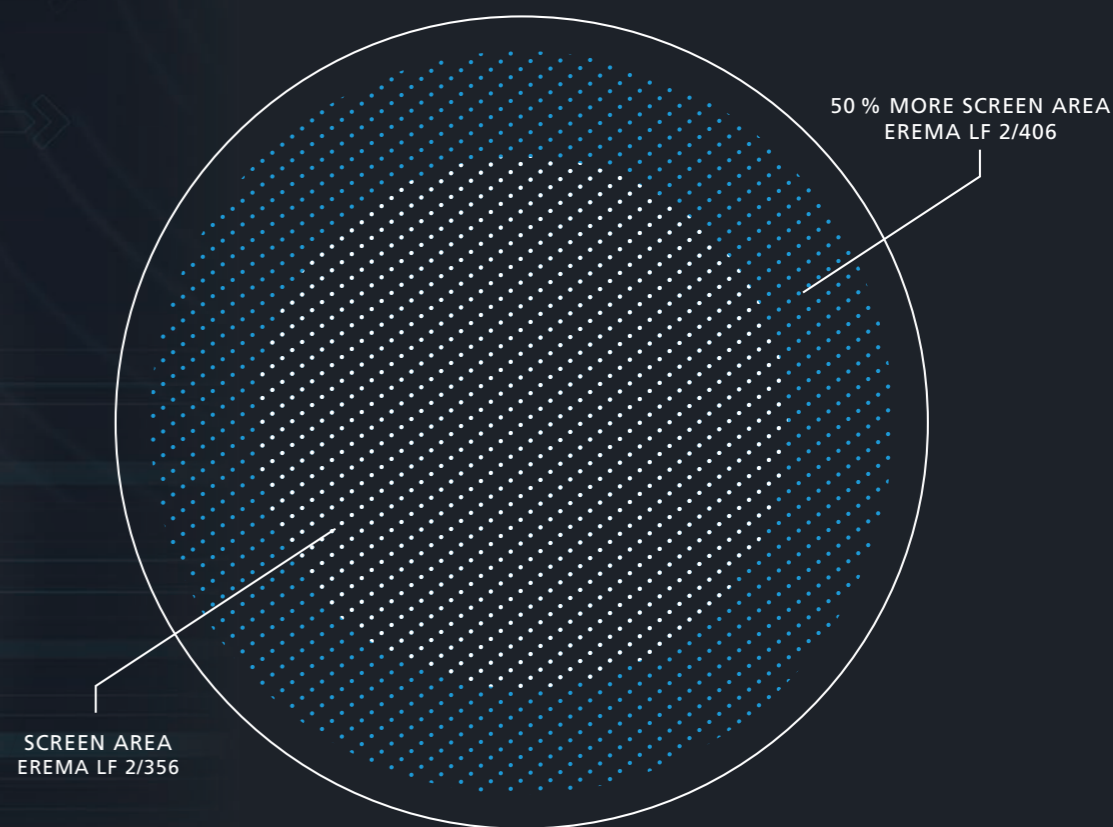

# MISSION: REMOVE CONTAMINANTS.

Whether it is paper, wood, aluminium or copper – the EREMA Laserfilter removes undesired impurities from the plastic melt reliably for you.

It is also the ideal solution for the efficient filtering of rubber, silicone and foreign polymers such as PET or PA (in polyolefin recycling). What's more: it is a high-performance filter which additionally stands out through remarkably strong throughput.

## ⚙️ RUBBER & CO.: TAKE OUT WHAT OTHERS CAN'T.

The Laserfilter is a real specialist when it comes to removing rubber-like, non-melting contaminants like silicone or linked polymers. This is because, whereas these contaminants can slip through the screens of traditional systems due to pressure and a longer dwell time on the scraper, the

Laserfilter has an effective means of dealing with this undesired effect. We call it continuous screen cleaning. In this process, rubber & co. are lifted off the screen immediately again by the scraper star and conveyed out reliably via the discharge screw.

PAPER



WOOD



RUBBER-LIKE  
CONTAMINANTS



ALUMINIUM

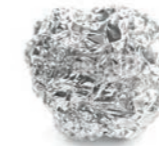

COPPER

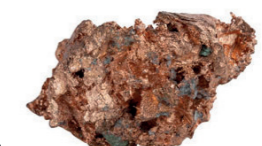

# MATERIAL-ALLROUNDER. FROM POST-CONSUMER TO PET.

The high-performance filter has the contaminants of a multitude of different plastics perfectly under control. The spectrum ranges from post-consumer and post-industrial applications with higher degrees of contamination to relatively clean PET material.

## POST CONSUMER.

The current trend which can be observed in the direction of "poorer" input material will continue. Films are becoming thinner and thinner in order to reduce packaging weight. However, the relative share of contaminants such as paper labels, for example, which have to be removed in the course of processing increases as a result. High-performance filtration is thus becoming more and more a key function in plastics recycling systems. The Laserfilter is the ideal solution for this task.

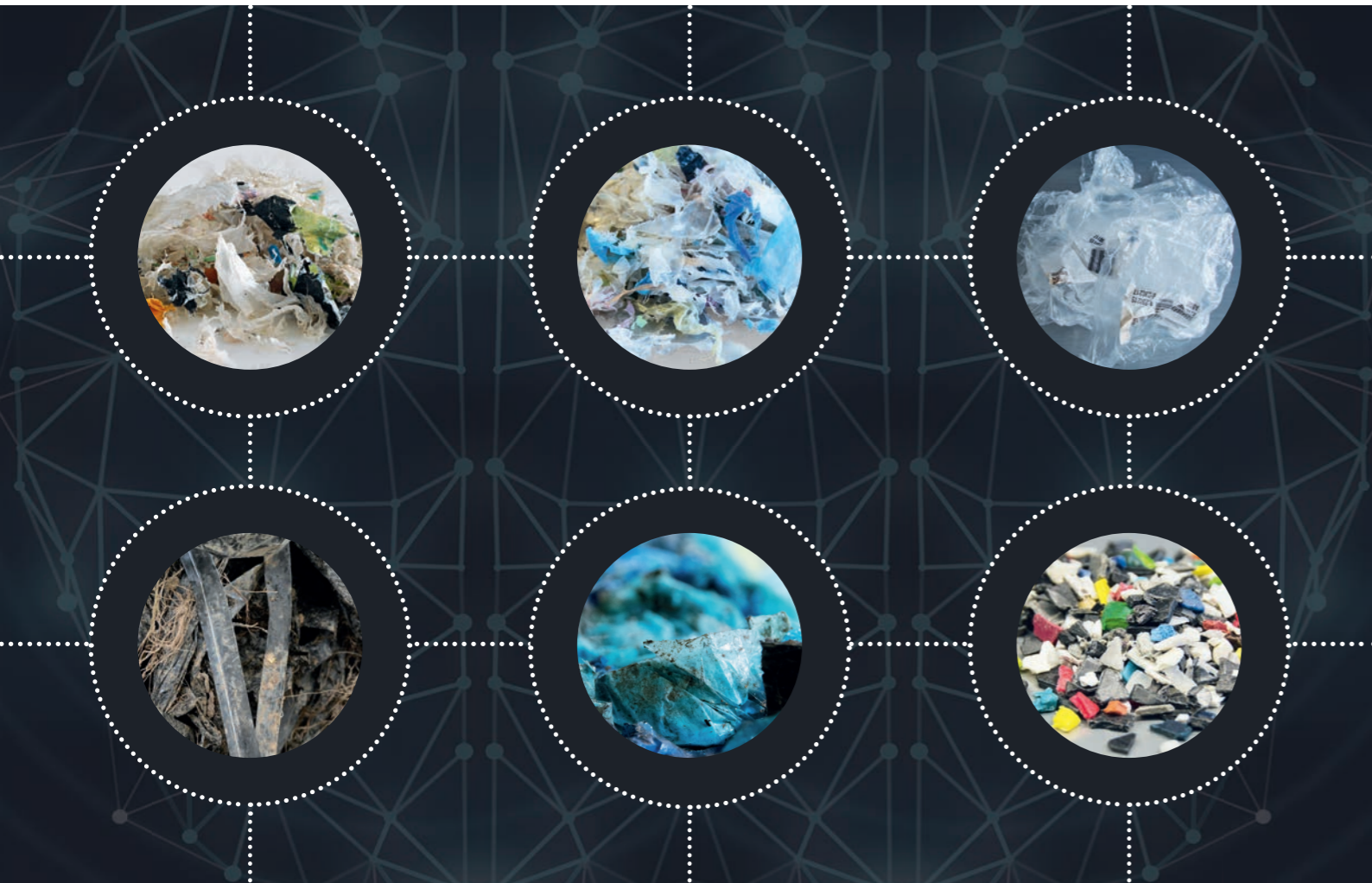

## EREMA LASERFILTER PET CLEAN. BETTER FOR PET.

The EREMA Laserfilter is also playing an increasing role in the PET sector. The reason for this is that the increased use of rPET in end products requires high process stability. This stability is also required if the degrees of contamination increase – which is currently the case. The benefits of the Laserfilter PET clean: it processes input material with a degree of contamination of over one per cent without any difficulty. The functional principle avoids dead spaces and makes for short dwell times, which in turn prevents "black spots" with PET. A system of this kind, which offers high melt and recyclate quality, has clear benefits especially in the case of food contact grade applications. Another argument which underpins the costeffectiveness of the Laserfilter: whereas the melt losses with piston filters are usually between one and two per cent, it has been possible to reduce them to clearly below one per cent with the Laserfilter thanks to the newly developed discharge unit.



## WHAT IS CLEAN, STAYS CLEAN STATIC SCREEN, ROTATING SCRAPER.

The Laserfilter screen is a clear and reliable line between contaminated and clean material. Because, thanks to the static design of the screen, it can be perfectly sealed, thus preventing any filtered contaminants from getting into the high-grade plastic melt. This is especially in the PET area a significant benefit over many traditional filter systems in which the screen rotates and a seal represents a bigger challenge.





# THE EFFICIENCY OF THE LASERFILTER.

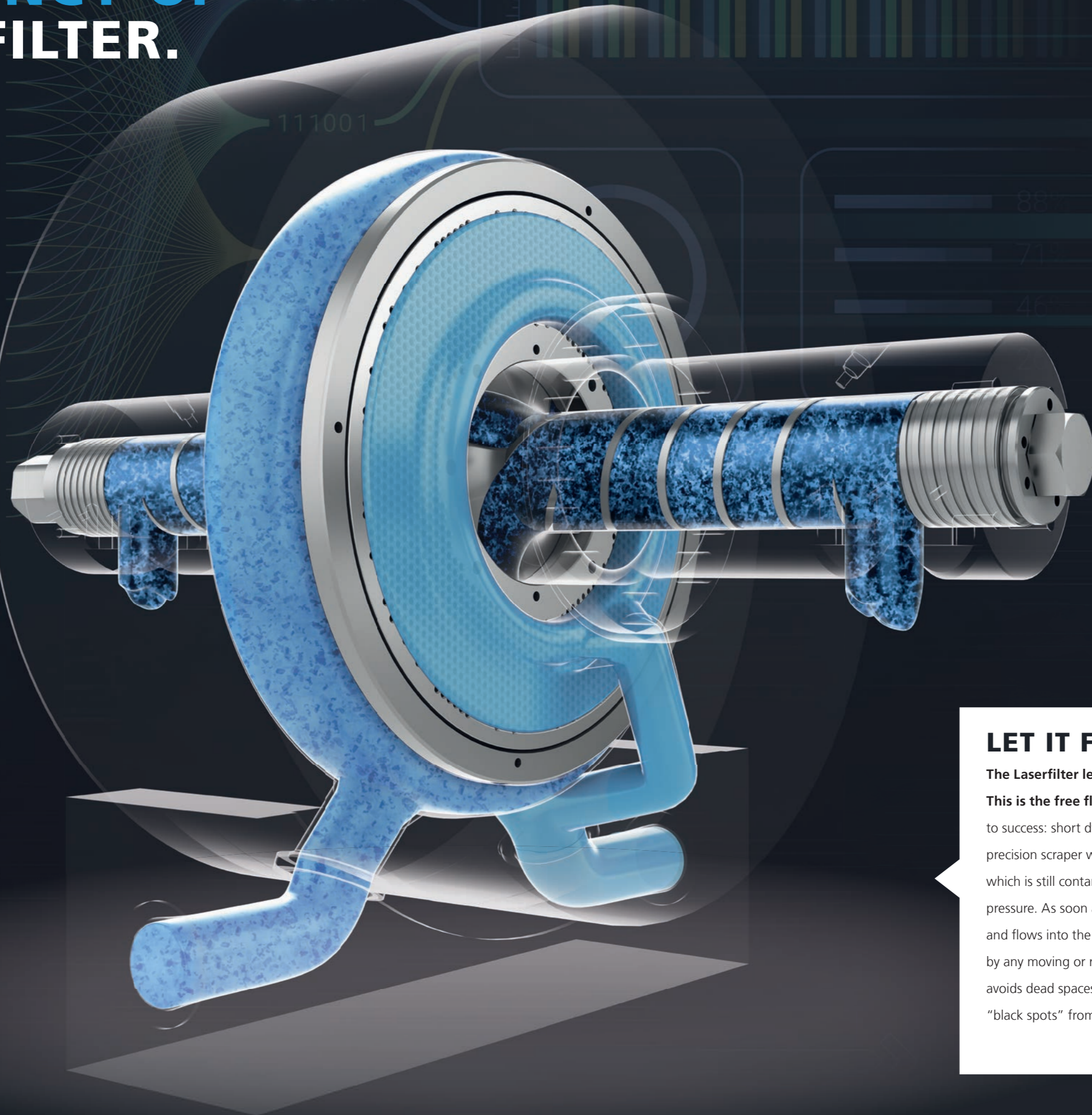

## LET IT FLOW.

**The Laserfilter lets the melt flow unhindered.**

**This is the free flow concept in a nutshell.** The key to success: short dwell times, static screens and a high-precision scraper which rotates only in the area of the melt which is still contaminated – while maintaining constant pressure. As soon as the melt is freed from its contaminants and flows into the clean section, its flow is not disturbed by any moving or rotating parts. This functional principle avoids dead spaces with short dwell times and prevents “black spots” from resulting..

# HOW THE LASERFILTER WORKS.

Free Flow. Because the melt quality is crucial.

**1** Coming from the extruder the contaminated plastic melt flows via a circular distributor ring into the housing between two parallel configured laser-drilled screen discs.

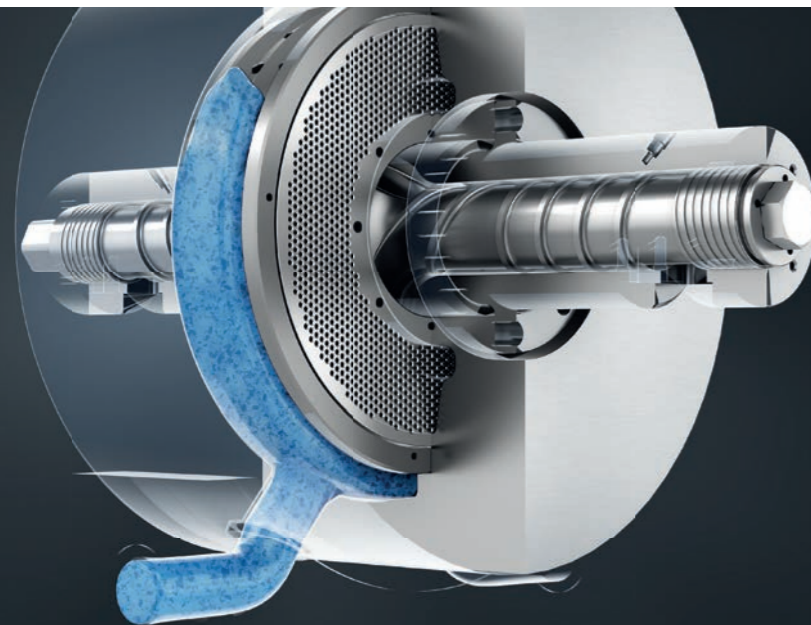

**2** The melt is pressed through the screen discs, flows through and leaves the filter in a clean state via the collection channel.

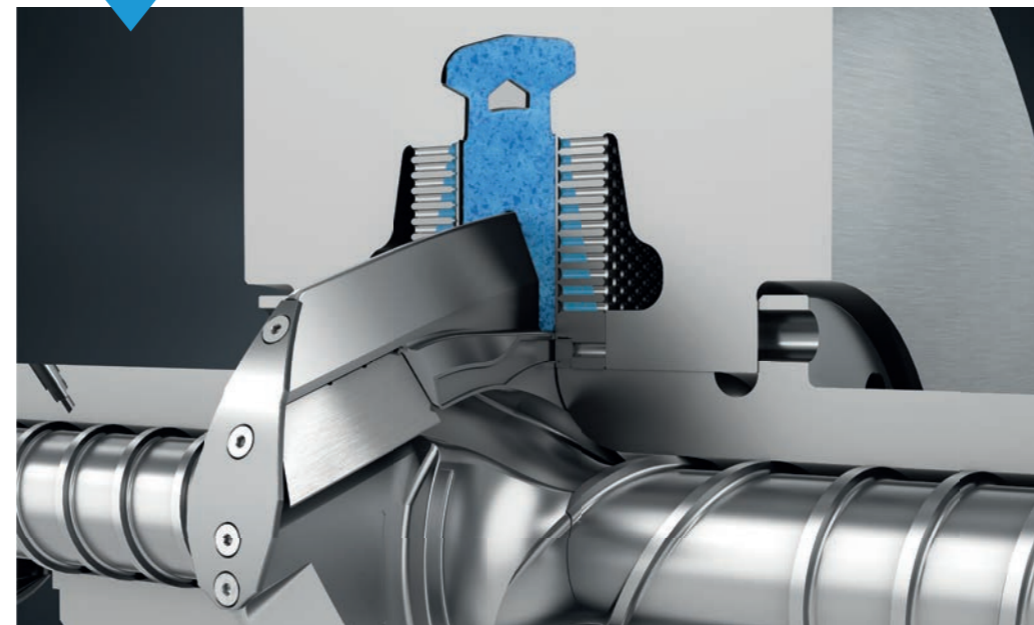

**3** The contaminant particles collect on the screen as the melt flows through. A scraper disc with three scrapers on each side rotates between the screen discs. The pressed on scrapers lift the contaminants immediately from the smooth, hardened screen discs and forward them directly to the discharge system.

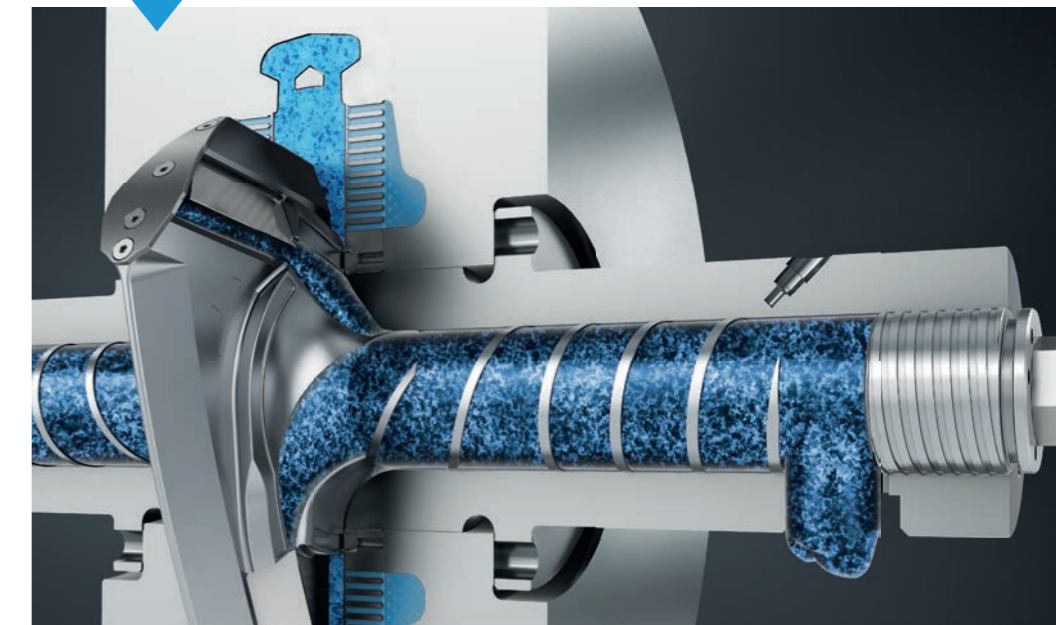

## CONTINUOUS SCREEN CLEANING: HIGH THROUGHPUT EVEN WITH HEAVY CONTAMINATION

One strong efficiency benefit of the Laserfilter is its high screen cleaning frequency. This is because three scrapers are available in every rotation to lift the contamination from the screen immediately and forward it to the coaxial discharge screw without delay. This ensures that the contaminant particles only spend an extremely short time on the screen. The screen holes are, therefore, quickly free again to filter new melt. Thanks to this continuous scraping, the filter achieves high throughput rates even when the melt is heavily contaminated.

## CONSTANT PRESSURE OPERATION = STABLE, CONTINUOUS PROCESS

The scraper and discharge screw speeds depend on the pressure and are controlled fully automatically ("constant pressure operation").

## WHAT IS CLEAN, STAYS CLEAN STATIC SCREEN, ROTATING SCRAPER.

The Laserfilter screen is a clear and reliable line between contaminated and clean material. Because, thanks to the static design of the screen, it can be perfectly sealed, thus preventing any filtered contaminants from getting into the high-grade plastic melt. This is a significant benefit over many traditional filter systems in which the screen rotates and a seal represents a bigger challenge. In short: EREMA Laserfilter – top level, reliable filtration.

## EXTREMELY LOW MELT LOSS

The optimised scraper technology ensures that the contaminants are discharged in a controlled manner and with only a minimum of melt – up to 50 % thickening is possible.

# POWERFUL FILTRATION.

Perfect design, high-precision manufacturing and a robust build.

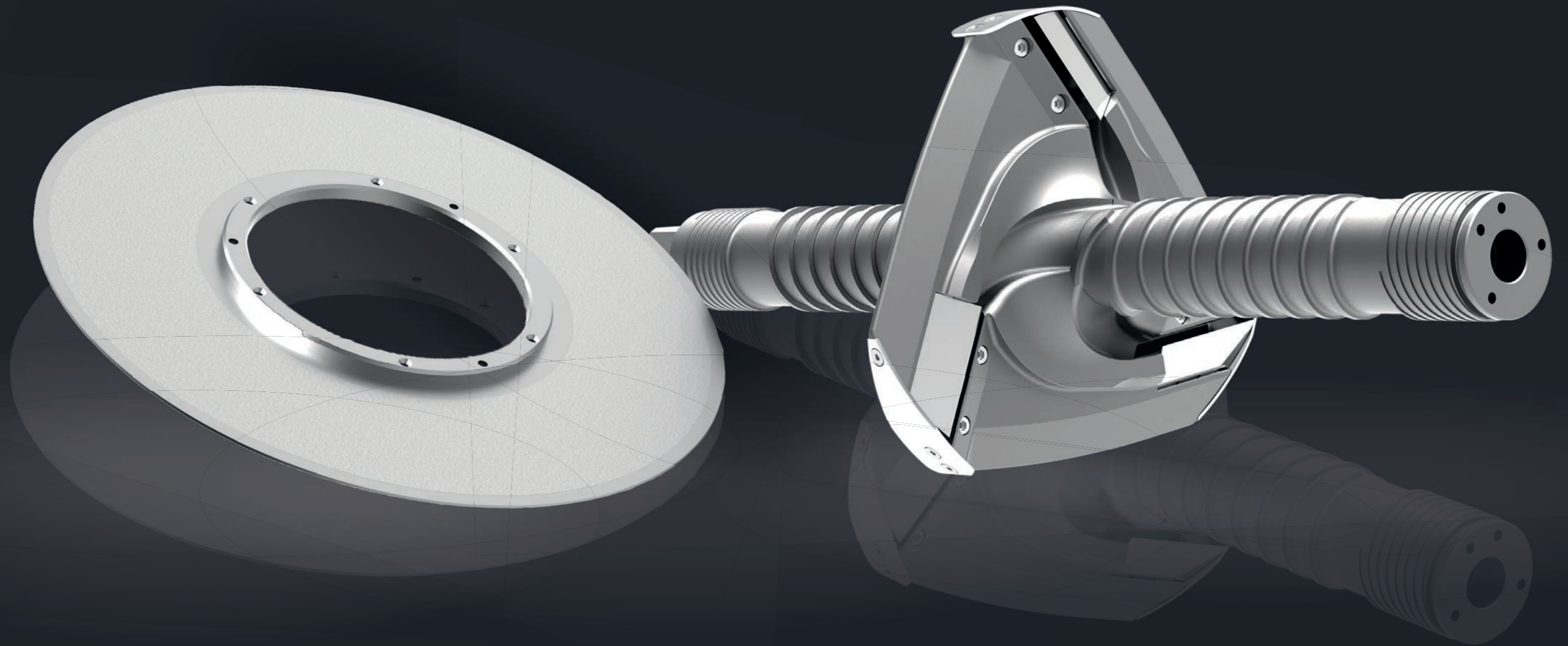



## THE SCREEN. STRENGTH IN SIMPLICITY.

Flat, straightforward design and 1.5 mm thick. The property spectrum of the filter screen made of hardened special steel is second to none. Because, thanks to its robust design and mechanical stiffness, the quality product even deals with stubborn contaminants with no trouble at all and stands out through a long service life. As a result, considerably fewer screen change processes are necessary, and the ones which are required are carried out in no time at all. Compared to screens with a cylindrical design, the flat design comes with another economic benefit: it can be manufactured relatively easily and thus, by comparison, more cost-effectively.



### INGENIOUS DESIGN

Flat screen, straightforward design



### LONG SERVICE LIFE

Notably fewer screen changes as a result



### PERFECT MATERIAL

Robust: made of hardened special steel, wall thickness around 1.5 mm



### QUALITY BONUS

The screen discs are made at the EREMA Group subsidiary 3 S in Austria – a company known for its high manufacturing quality.



### EXTREMELY STIFF

Excellent mechanical stiffness



### PARTICULARLY FINE

Thousands of ultrafine drilled holes, filtration fineness up to 70 µm



### COST BENEFIT

Thanks to the flat design the screen can be made easily and inexpensively compared to screens with a cylindrical design



### DESIGN BONUS

The screen does not turn, instead it is used statically so there is a perfect seal between contaminated and clean melt

### Laser technology

## THE FINE DIFFERENCE

The Laserfilter gets its name from the filter screen. Advanced laser technology cuts thousands of ultrafine holes into a hardened special steel disk. A self-cleaning effect is achieved through the conical shape of the holes. The filtration fineness reaches up to 70 µm.



## THE SCREEN. STRENGTH IN SIMPLICITY.

Flat, straightforward design and 1.5 mm thick. The property spectrum of the filter screen made of hardened special steel is second to none. Because, thanks to its robust design and mechanical stiffness, the quality product even deals with stubborn contaminants with no trouble at all and stands out through a long service life. As a result, considerably fewer screen change processes are necessary, and the ones which are required are carried out in no time at all. Compared to screens with a cylindrical design, the flat design comes with another economic benefit: it can be manufactured relatively easily and thus, by comparison, more cost-effectively.



### LONG FILTRATION CYCLES

Rotating scraper disc for self-cleaning enables days and weeks of continuous filtration



### SELF-ADJUSTING SCRAPER

Through contact pressure of the scraper on the filter surface



### INNOVATIVE DESIGN

Ensures better discharge capacity – lowest melt losses through increased thickening



### SELF-SHARPENING SCRAPER KNIVES

As the screen is harder than the scrapers



### HIGH SCREEN SERVICE LIFE

Considerably longer screen service life through increased cleaning efficiency



### PERFECT MATERIAL

Top-quality scraper elements made in highly wear-resistant material



### YOUR QUALITY BONUS

The screen elements are made at the EREMA Group subsidiary 3 S in Austria – a company known for its high manufacturing quality

Continuous screen cleaning

### EXTREMELY SHORT PARTICLE DWELL TIME

Not just one but three knives are located on each side of the continuously rotating scraper star. Every contaminant particle only comes into contact very briefly with the screen as it is picked up by one of three knives, lifted and conveyed immediately to the discharge system; this means that it is difficult for so-called “soft particles” such as rubber or silicone contaminants to pass through the screen. Moreover, the rapid lifting of the particles prevents an undesired grinding effect of the contaminants.

# POWERFUL. THROUGH AND THROUGH. FROM SINGLE TO QUATTRO.

Up to 9,000 kilograms of filtrated melt per hour. The brand new EREMA

Laserfilter LF 406 QUATTRO is a real top performer and sets the standard in terms of throughput. But the series not only delivers remarkable, compelling performance at the top end of the scale.

Because whether it is SINGLE, TWIN, TRIPLE or QUATTRO –

every individual design ensures you have high-capacity melt filtration even with high degrees of contamination. Your specific requirements and desired throughput finally decide which solution is the best for you.



## LF 2/406

Total filter area: 1950 cm<sup>2</sup>  
 Scraper disc speed: 1–10 rpm  
 Max. operating pressure: 320 bar  
 Throughput capacity: 300–3000 kg/h

## LF 2/406 TWIN

Total filter area: 3900 cm<sup>2</sup>  
 Scraper disc speed: 1–10 rpm  
 Max. operating pressure: 320 bar  
 Throughput capacity: 1200–5200 kg/h

## LF 2/356

Total filter area: 1342 cm<sup>2</sup>  
 Scraper disc speed: 1–10 rpm  
 Max. operating pressure: 320 bar  
 Throughput capacity: 200–2000 kg/h

## LF 2/356 TWIN

Total filter area: 2684 cm<sup>2</sup>  
 Scraper disc speed: 1–10 rpm  
 Max. operating pressure: 320 bar  
 Throughput capacity: 800–3500 kg/h

## LF 2/406 TRIPLE

Total filter area: 5850 cm<sup>2</sup>  
 Scraper disc speed: 1–10 rpm  
 Max. operating pressure: 320 bar  
 Throughput capacity: 2700–6900 kg/h

## LF 2/406 QUATTRO

Total filter area: 7800 cm<sup>2</sup>  
 Scraper disc speed: 1–10 rpm  
 Max. operating pressure: 320 bar  
 Throughput capacity: 3700–9000 kg/h

## LF 2/356 TRIPLE

Total filter area: 4026 cm<sup>2</sup>  
 Scraper disc speed: 1–10 rpm  
 Max. operating pressure: 320 bar  
 Throughput capacity: 1800–4600 kg/h

## LF 2/356 QUATTRO

Total filter area: 5368 cm<sup>2</sup>  
 Scraper disc speed: 1–10 rpm  
 Max. operating pressure: 320 bar  
 Throughput capacity : 2500–6000 kg/h

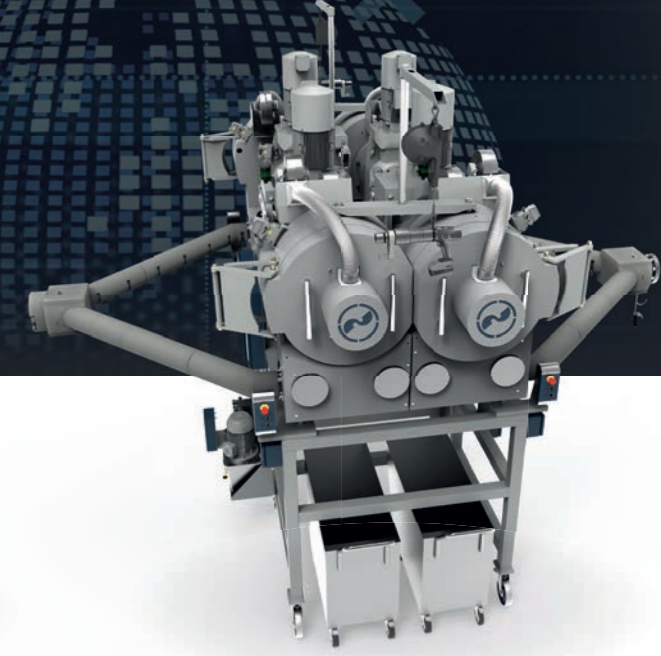
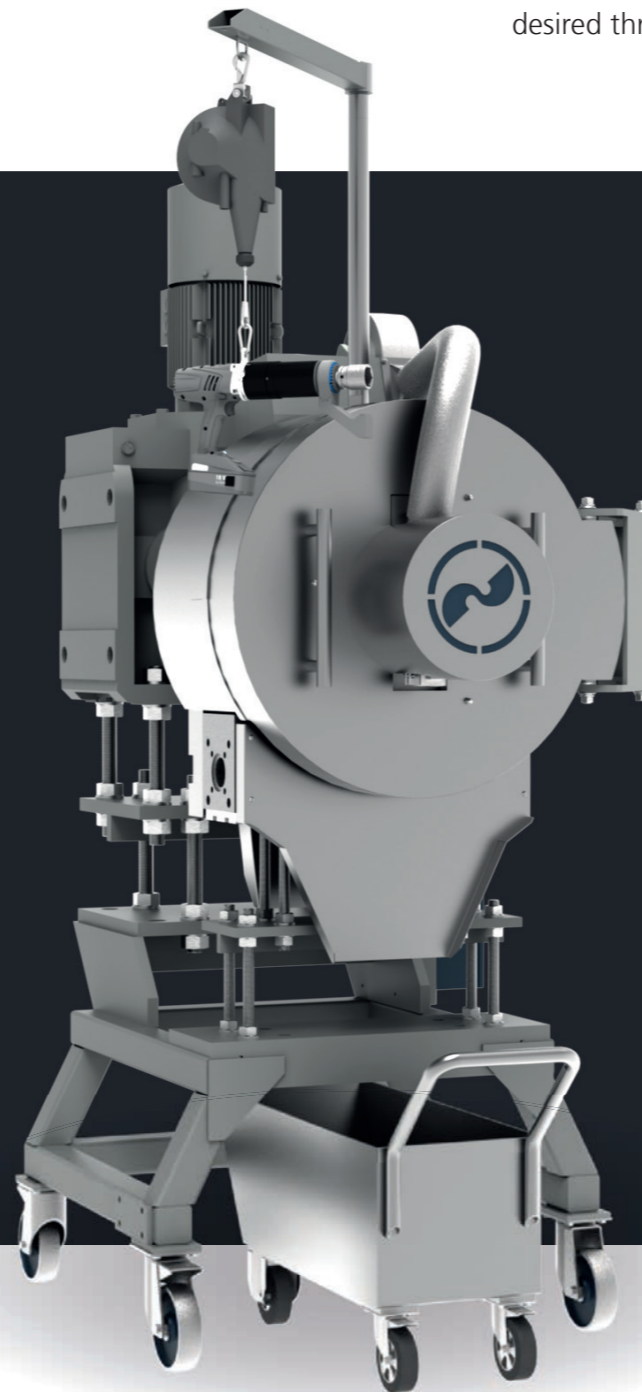

# THE LASERFILTER – IN A CLASS OF ITS OWN IN EVERY RESPECT.

The diagram shows the superiority of the Laserfilter compared to other filter systems available on the market with regard to the two main parameters of process consistency (pressure constant) and filtration capacity (level of contamination of the melt).

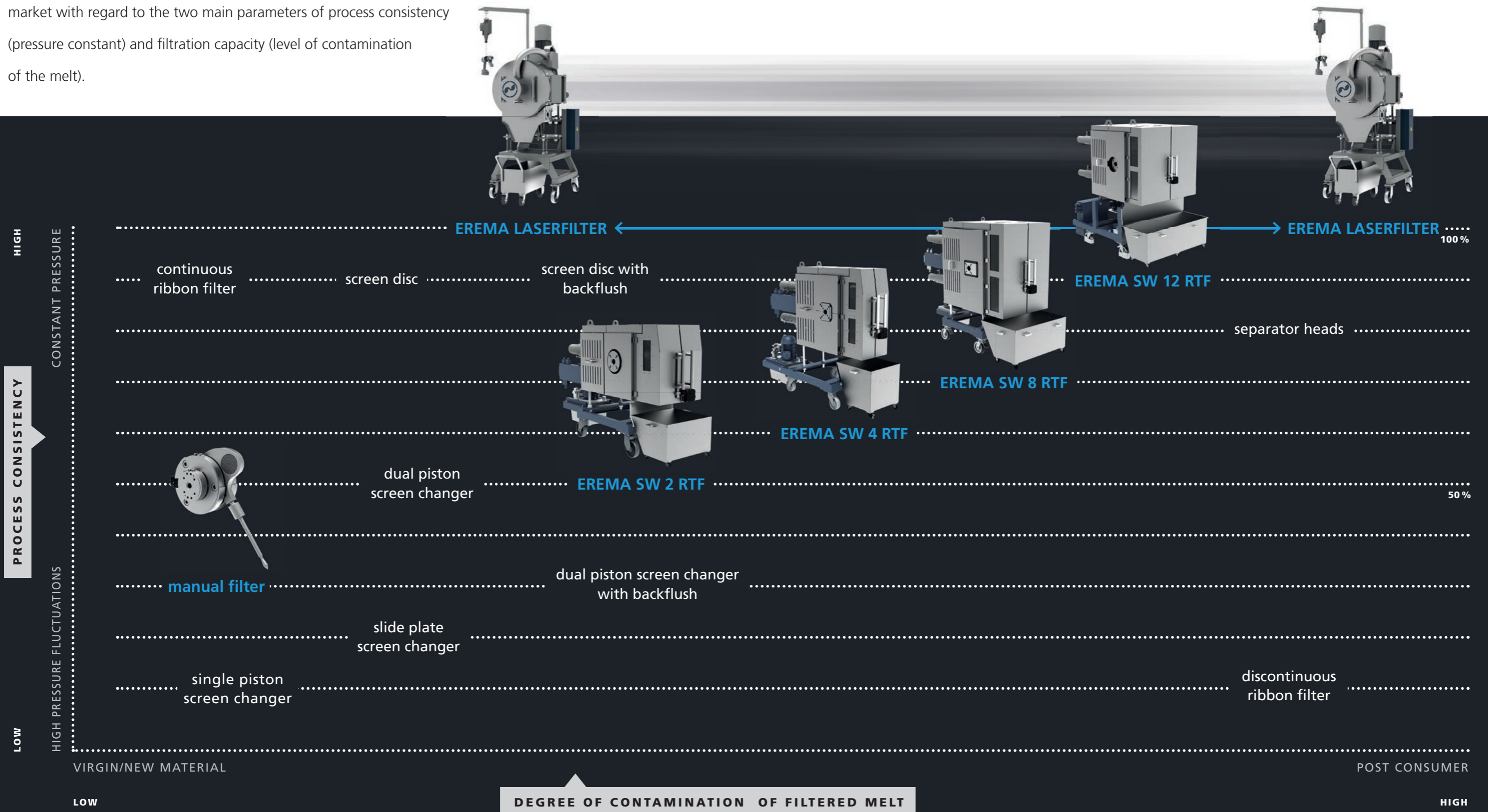

# LOCK & CHANGE: FILTER CHANGE WITHOUT STOPPING MACHINE.

With the shut-off slider option (available starting with the TWIN model) the machine continues to produce when one of the screens has to be changed. Thanks to the shut-off slider, the melt flow is stopped via the left filter. The screens on this filter can be changed while the right filter continues to produce.

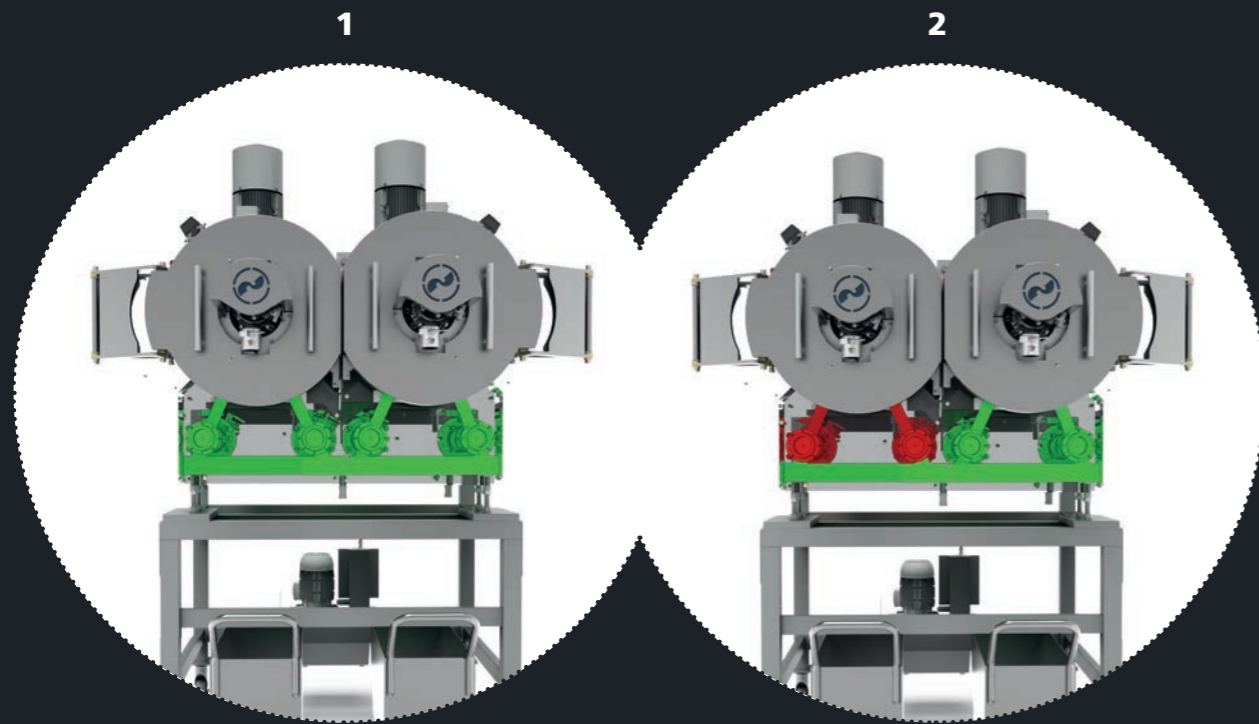

Both filters produce

Servicing during ongoing operation

## TORQUE SCREWDRIVER

The torque screwdriver is always to hand for fast screen changeover.



## 2.600 kg/h. With a filtration fineness of 90 µm.

The best practice example underpins the performance of the EREMA Laserfilter.

The task: filtration of plastic melt with non-melting content such as paper, wood, aluminium, copper etc.



**INPUT:** PE washed shreds with 2 to 3 % residual contamination (PET, aluminium, paper, wood)



**FILTRATION:** Thickening 41 % – contamination removal with lowest melt loss!



**OUTPUT:** PE recyclate in film quality

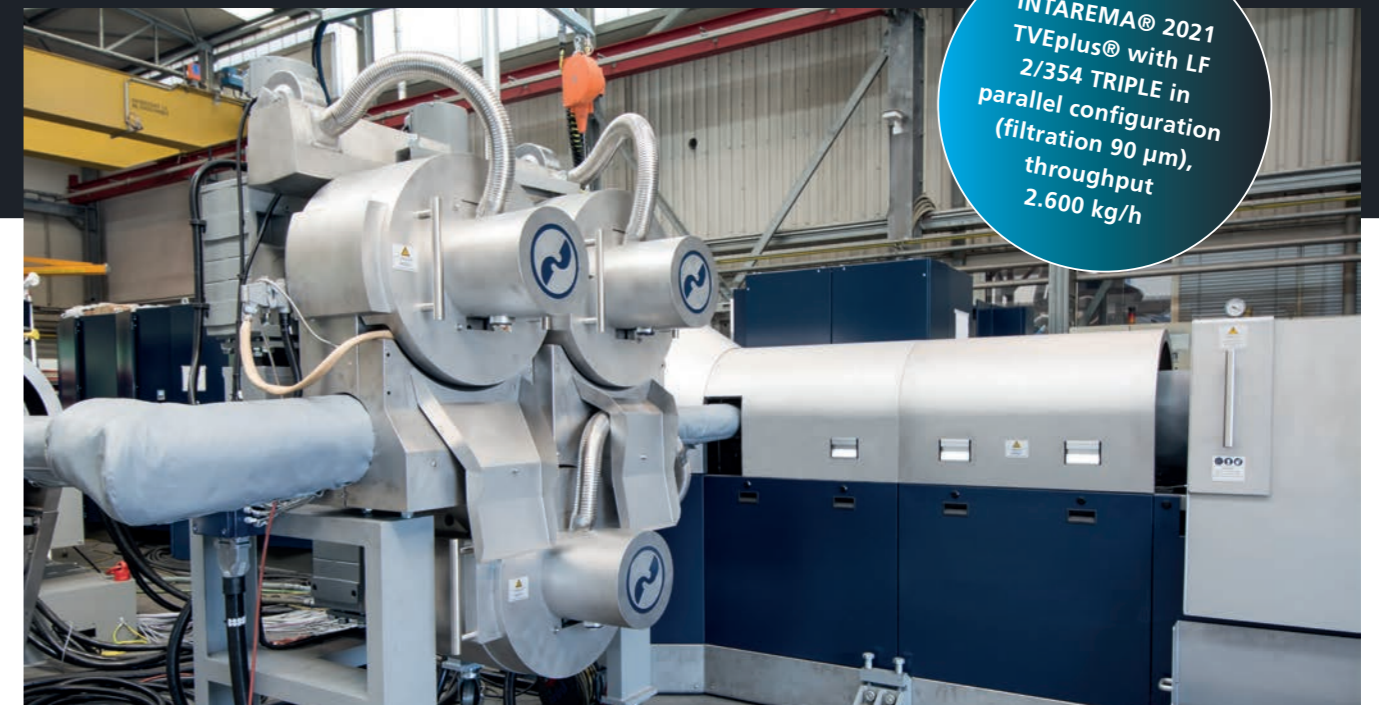
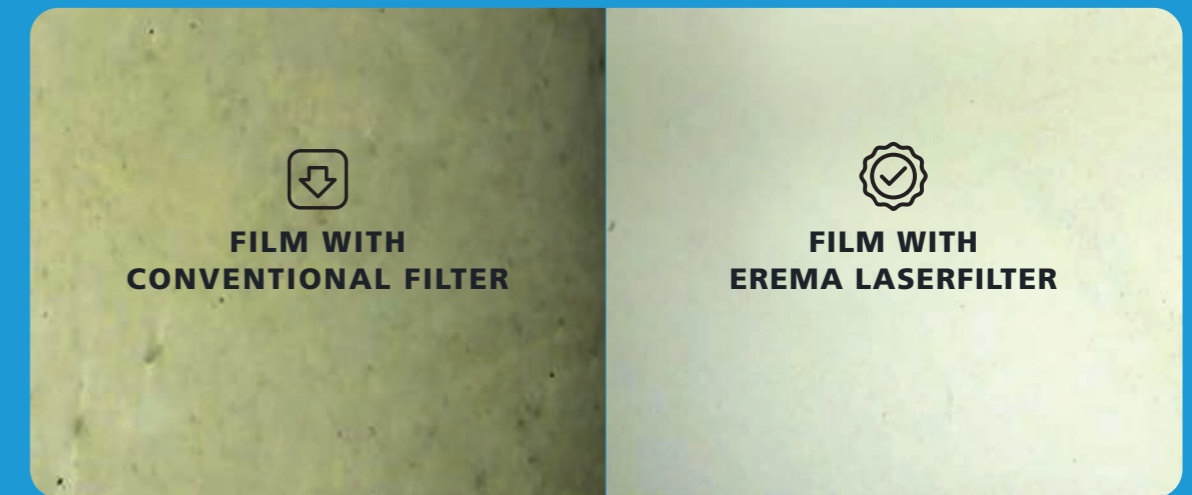

INTAREMA® 2021 TVEplus® with LF 2/354 TRIPLE in parallel configuration (filtration 90 µm), throughput 2.600 kg/h



